

g.tec medical engineering GmbH
4521 Schiedlberg, Sierningstrasse 14, Austria

Tel.: (43)-7251-22240-0

Fax: (43)-7251-22240-39

office@gtec.at, <http://www.gtec.at>



g.[®]MOBIIlab SIMULINK
highspeed
ONLINE
processing
MOBILE LABORATORY

**Calculate Heart Rate and
Respiration Rate with
g.MOBIIlab+ and Simulink
v3.12.03**

Copyright 2012 g.tec medical engineering GmbH

Introduction

g.MOBILab+ is a biosignal acquisition system for EEG, ECG, EMG, EOG and other sensors. In this tutorial the recording of an ECG and a respiration signal will be discussed. Furthermore the usage of Simulink blocks for the detection of the heart rate and of the respiration will be shown.

Required Components

To perform the tutorial the following components are required:

- **g.MOBILab+** biosignal acquisition device
- **Simulink Highspeed On-line Processing** blocks for g.MOBILab
- ECG cable and ECG electrodes for g.MOBILab+
- Respiration sensor for g.MOBILab+
- PC or notebook with Bluetooth or serial connector
- MATLAB and Simulink Release 2012a

Quickstart

The corresponding Simulink model can be started from the MATLAB **Start** button

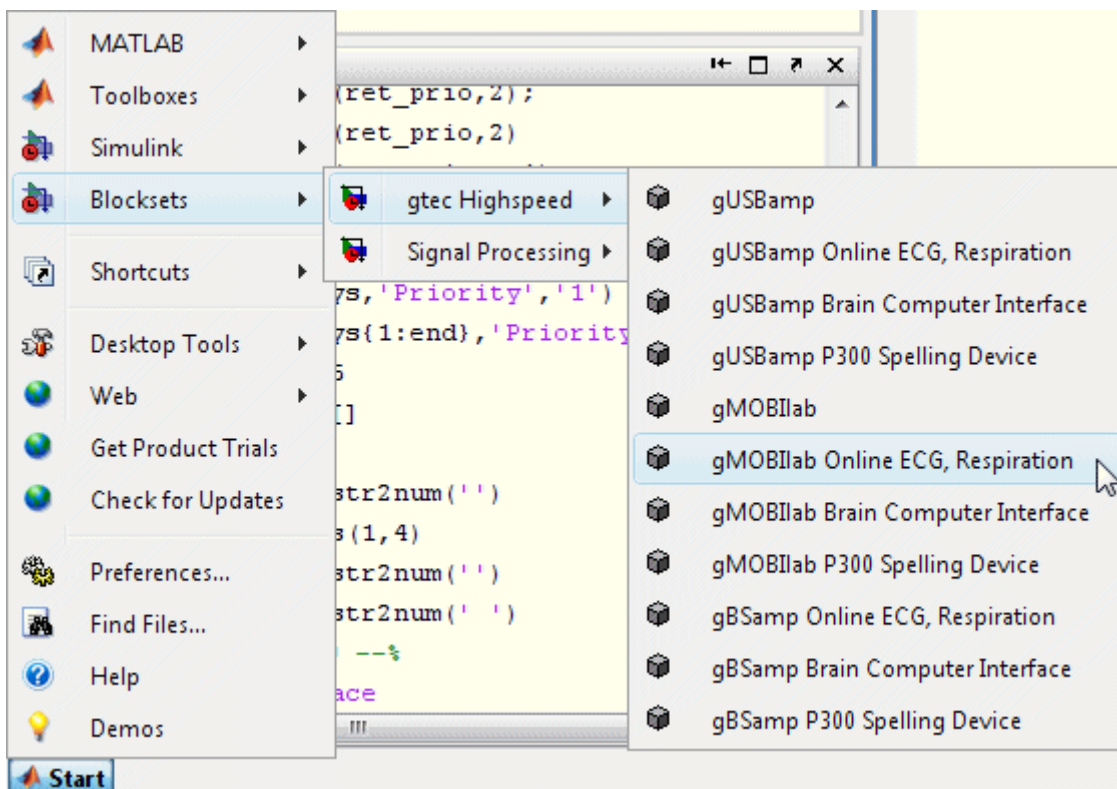

or by typing `gMOBILabplusECG` into the MATLAB command line.

The model below will be opened:

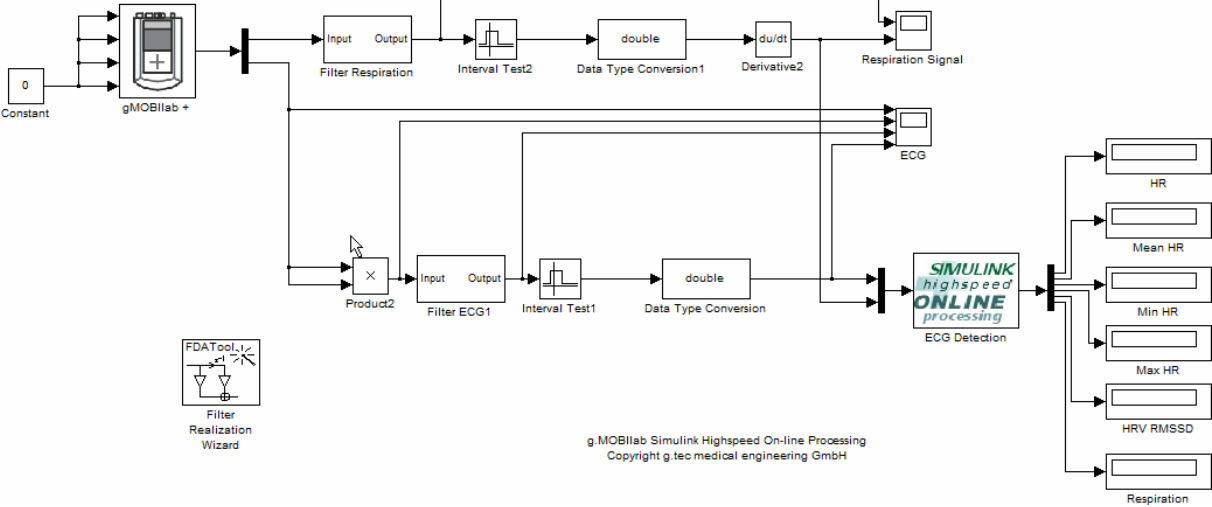

Double click onto the block to open the following window:

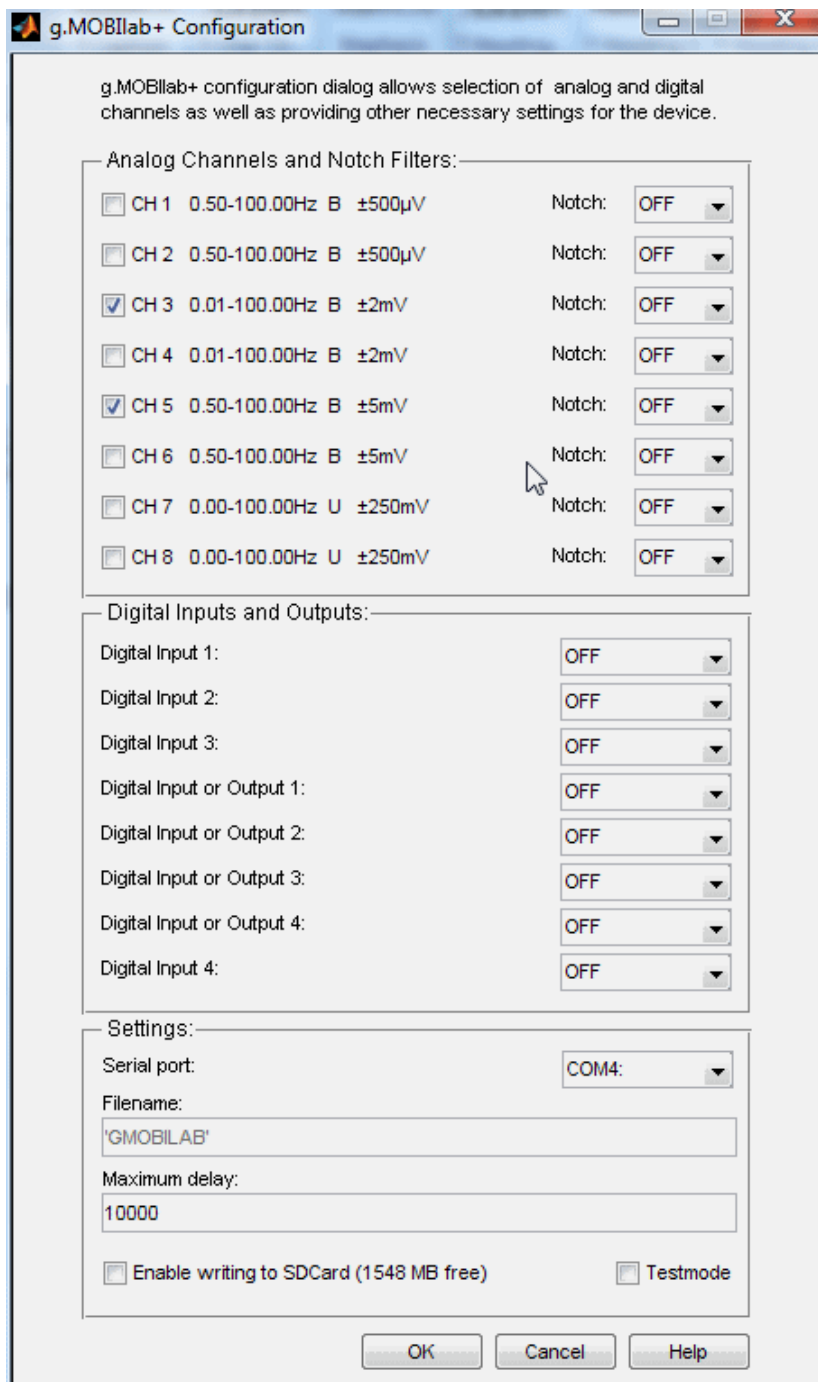

The check boxes for the analog channels (**CH 1** to **CH 8**) allow specifying the biosignal channels. Select channels 3 and 5 (**CH 3** and **CH 5**) to read in a DC channel with a lower cutoff frequency of 0.01 Hz and an ECG channel.

Check the 4 digital inputs and the 4 digital I/Os if digital inputs or outputs should be used. Digital lines 1, 2, 3 and 8 can be defined as inputs. The digital channels 4 to 7 can be defined either as inputs or outputs. **Digital Channel 3** can be used to read in data from the external switch that can be connected to g.MOBILab+. Output channels are useful to send trigger signals to external devices for synchronization or to control an external device.

Max. delay (ms) allows to specify the maximum possible delay that the g.MOBIIlab driver block can have. The highly optimized driver block ensures that all data from the acquisition device is read into Simulink. If the PC is busy with other tasks and cannot perform the Simulink operations fast enough, the driver buffers the acquired data. After returning to the Simulink task the operations are performed as fast as possible. If the driver block detects a buffer overflow an error message is shown.

Pull-down menu **Serial Port** can be used to select the appropriate serial port of your PC or notebook.

For this tutorial select channel 3 (**CH 3**) for ECG and channel 5 (**CH 5**) for respiration. No digital channels are used in this tutorial. Select the correct serial port for your device in the **Serial port** pull down menu.

Now g.MOBIIlab+ is correctly initialized.

Press **OK** to accept the settings and to close the window.

Connect a **MUX** block to split the DC and ECG channels.

The driver block reads in the data in Microvolts.

Respiration

Copy the **Filter Realization Wizard** into your model to design a lowpass filter. The sampling frequency of g.MOBIIab is 256 Hz for all channels. Enter 256 in the editor box **Fs** and set the cut-off frequency **Fc** to 10 Hz. Set the order of the lowpass filter to 4 under **Specify order**.

Click the **Design Filter** button to investigate the **Magnitude** and **Phase Response**.

Click on **Realize Filter** to create a Simulink block with the settings.

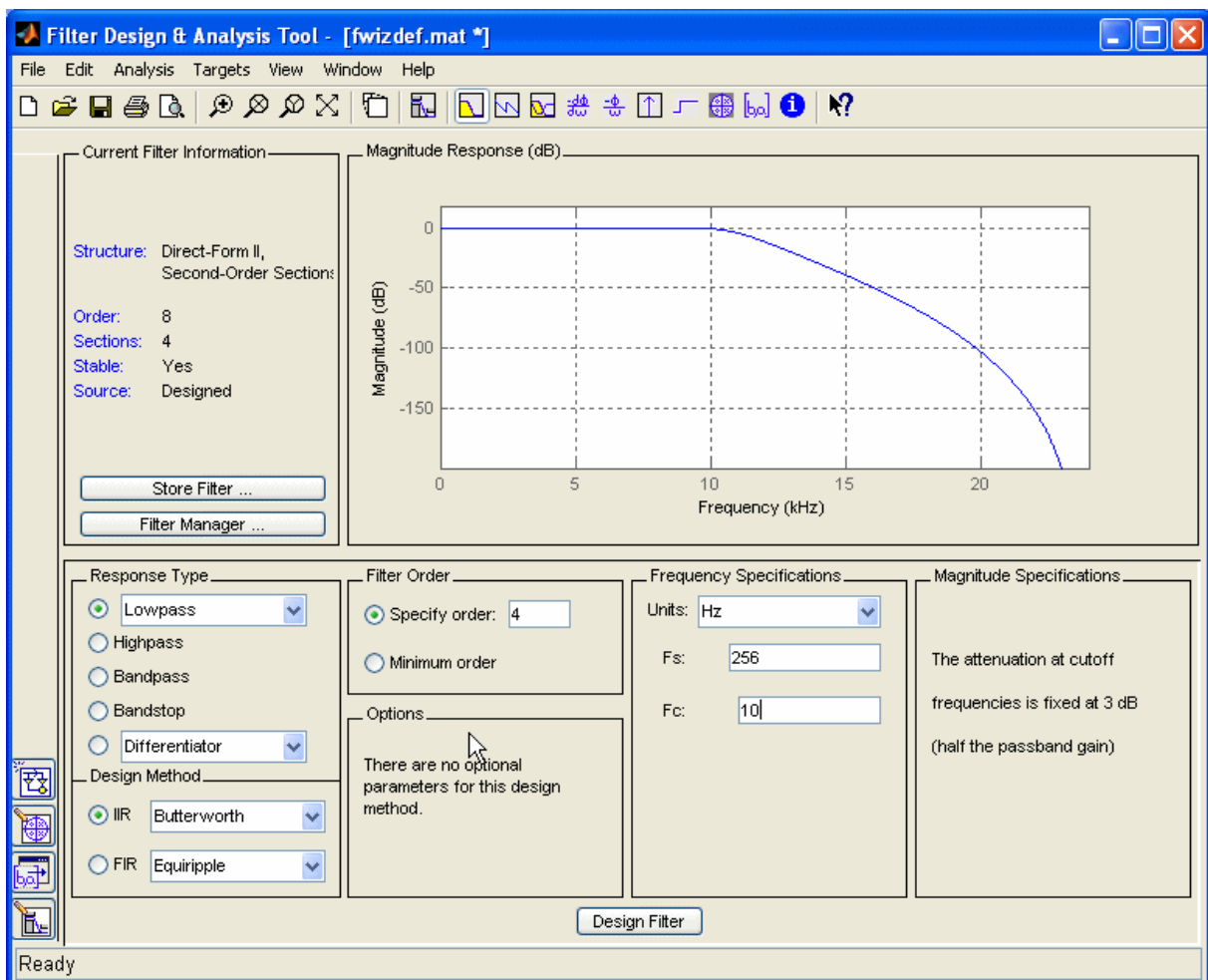

Connect the filter to the **Gain** block.

Copy the **Interval Test** block into the model. The block detects zero-crossings of the respiration signal. The **double** block converts the Boolean output of the **Interval Test** block into doubles in order to perform the first derivation in the next block.

Use the **Respiration Signal** scope to investigate the respiration signal on channel 1 and the detected zero-crossings on channel 2.

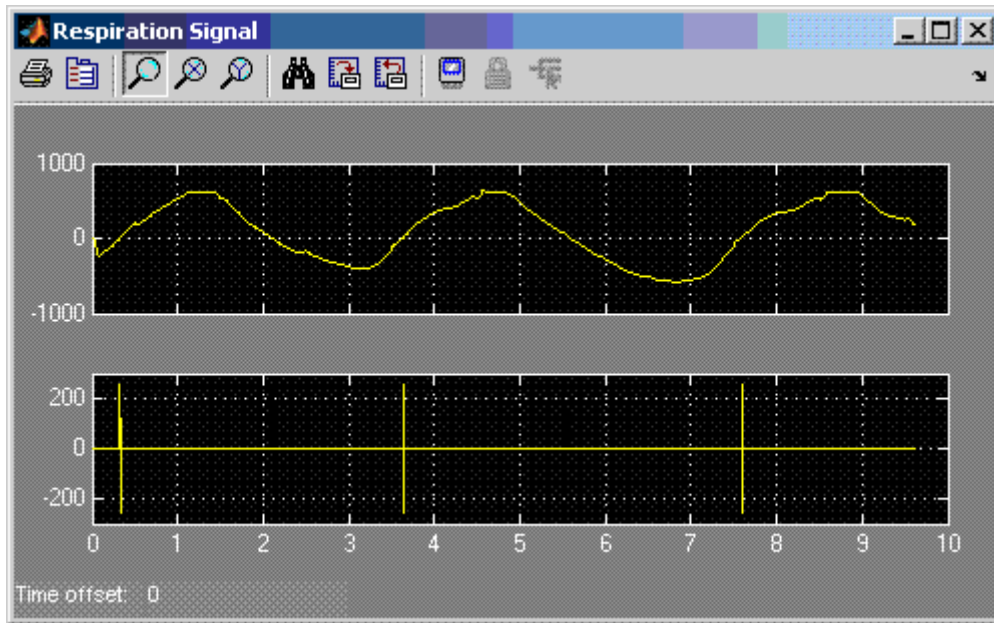

The **Respiration** display block shows the respiration cycles per minute.

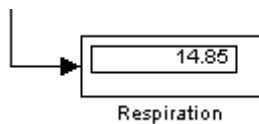

ECG Processing

Copy the **Product** block into the model and connect it to the **Gain** block of the ECG signal. This block is used to square each input sample.

Start again the **Filter Realization Wizard** to design a bandpass filter for the ECG signal. Design a **Butterworth** bandpass filter with a lower cut-off frequency of 5 Hz and an upper cut-off frequency of 100 Hz. Set the order to 4.

Click the **Design Filter** button to investigate the **Magnitude** and **Phase Response**.

Click on **Realize Filter** to create a Simulink block with the settings.

Connect the filter block to the **Product** block.

Copy the **Interval Test** block into the model. The block detects amplitudes above 2 mV and below 10 mV. The **double** block converts the **Boolean** output of the **Interval Test** block into doubles in order to perform the first derivation in the next block.

Use the **ECG** scope to investigate the ECG signal on channel 1, the squared signal on channel 2, the bandpass filtered signal on channel 3 and the detected QRS complexes on the last channel.

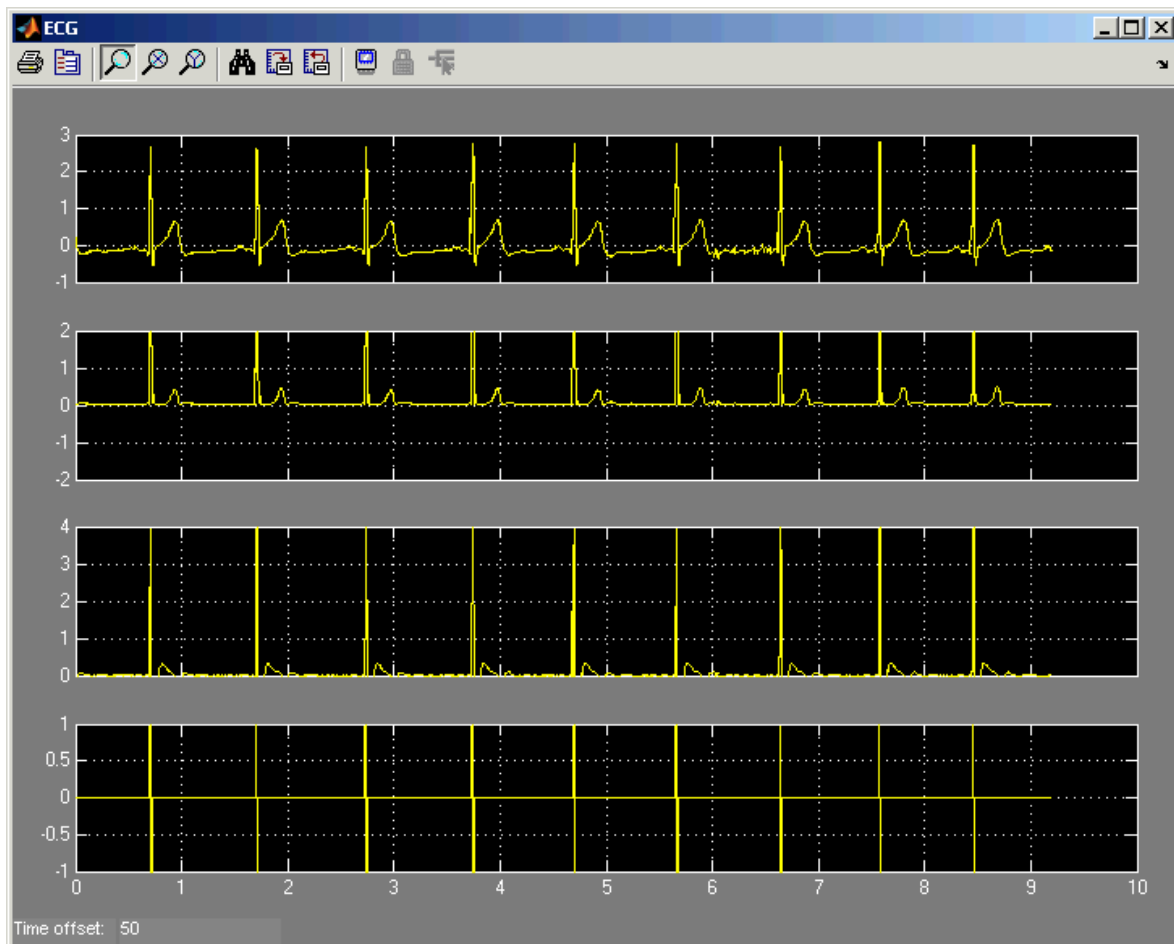

The block **ECG Detection** is a MATLAB S-Function that performs error detection of the QRS complex detector and of the respiration signal. Input 1 reads in the QRS complex signal and channel 2 the zero-crossings of the respiration channel.

If the interval from the last heart beat to the current heart beat (RR interval) is 50 % longer or shorter than the previous interval then the interval is not accepted.

The block has 6 outputs which are connected to the display blocks:

HR	actual heart rate in beats per minute
Mean HR	mean HR of the last 10 beats
Min HR	minimum HR of the last 10 beats
Max HR	maximum HR of the last 10 beats
HRV RMSSD	heart rate variability in ms of the last 10 beats. RMSSD is the root mean square of the squared difference of successive RR intervals.
Respiration	respiration cycles per minute

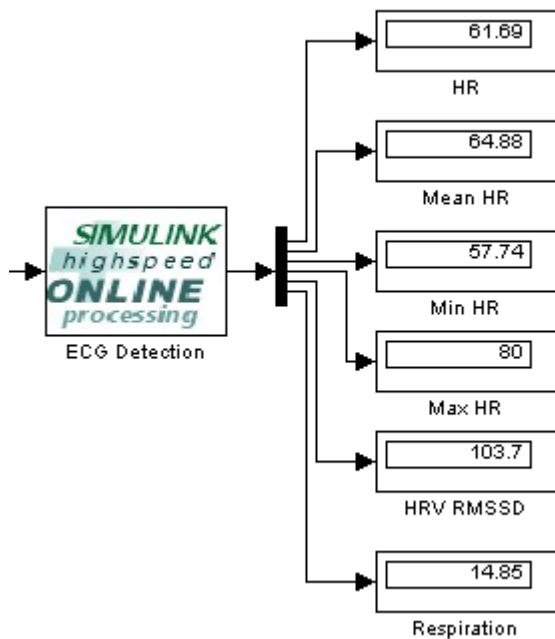



contact information

g.tec medical engineering GmbH
Sierningstrasse 14
4521 Schiedlberg
Austria

tel. +43 7251 22240
fax. +43 7251 22240 39
web: www.gtec.at
e-mail: office@gtec.at